

Excreta disposal for physically vulnerable people in emergencies

All kinds of people experience a variety of physical difficulties, which can make it difficult to use standard designs of latrines. For example, elderly men and women with weak legs may struggle to squat or rise from the squatting position when using a standard latrine, and there may be nothing for a pregnant woman, or a person with a high fever to hold onto for balance as they use the latrine. There may not be enough space for a mother to enter the latrine cubicle to help her child or a dependant family member, and some people may be bedridden, for example, in a hospital situation.

Effective sanitation in emergencies is important for human health but also for human dignity, and this should be a right for all people, whatever their abilities or limitations. In humanitarian situations there may also be increased numbers of people with physical disabilities, for example, from injuries or trauma caused by an earthquake or a tsunami, or as the result of conflict or unexploded landmines and ordinance.

With quite simple modifications, latrines can be made user-friendly for physically vulnerable people. This Technical Brief highlights good practice in this area. It has drawn its information from OXFAM good practice in the field, including discussions with users who have disabilities, and from WEDC research 'Water and Sanitation for Disabled People and Other Vulnerable Groups' (Jones and Reed, 2005).

Designing facilities with physically vulnerable people

Men, women and children come in a range of shapes, sizes, strengths and abilities, and may find it difficult to use standard toilet and bathing facilities for many reasons. The challenge for the designer is that the range of needs varies greatly. For example, some people may have problems moving around, because of a physical impairment, so they may need to use crutches or a wheelchair. They may have sight impairment, which limits their mobility. Elderly women and men, and people who are sick, including those with HIV/AIDS, may be weak, and have poor balance. They may have difficulty using their hands or reaching, because of stiff joints or missing limbs, or they may be paraplegic or bed bound.

The ideal should be for the person to be as self-reliant as possible and be able to access excreta disposal facilities independently. However, where this is not possible, the support and involvement of a carer will also be necessary. It is important to also involve the carer in discussions about their own needs to be able to assist the physically vulnerable person.

The most important principle is that the designer should design with disabled people and their carers. The PHE and PHP teams should discuss the needs and preferences of the physically vulnerable people and their carers. People with disabilities are often the most marginalised and hidden within communities and in most situations are unlikely to demand or request specific help. The team will need to be pro-active in finding them within the affected communities to be able to discuss their needs. Disabled women will often be more hidden and have even less voice than disabled men.

Approaches to improving Access for All

When considering excreta disposal for camp environments there are some general principles of good practice when designing latrines for improved access.

- 1. Providing equipment and assistive devices to individuals according to their needs:** Examples may be to provide a moveable seat, or a commode chair.
- 2. Adapting and modifying existing facilities to make them more accessible:** solutions may be provided according to identified need, such as adding a ramp, or a handrail, or installing a seat.
- 3. Designing and constructing facilities that are accessible for all:**

This aims to provide facilities that are designed to meet the needs of the widest possible range of users irrespective of age or ability. This approach is known as 'Inclusive Design', 'Universal Design' or 'Design for All'.

This may mean providing additional space within a unit and ensuring an easy access pathway to the latrine.

But the team should also be aware of the people in the particular vicinity who will be using the facilities and further adapt them to suit their specific needs where required.

In practice, a combination of all three approaches is likely to be needed.

Designing excreta disposal with people with disabilities

1. Use PHP staff and health staff working in the camp or area to identify where people with disabilities are living. They may be hidden from sight.
2. Ask people who have disabilities and their carers what facilities they need or would prefer.
3. Consider the provision of individual facilities such as bed pans, commode chairs, or individual latrine units, or consider designing in disabled units into blocks of latrines in camp settings.
4. The provision of easy access to water near to the latrine will also be helpful for a person who has difficulty with mobility.
5. Privacy and security are important for all people when using latrines or bathing. This is particularly important for women.

Providing equipment and assistive devices to individuals

Commode chair

This is a chair, which has a seat with a hole in it. A pot is supported underneath the seat which can be removed for emptying and cleaning. The frame may be wood, metal, plastic or bamboo.



One model of the commode chairs provided to disabled people in the IDP camps in Pakistan

Photo: Saira Raza

Providing a commode chair to individual people with disabilities in a camp setting in Pakistan

Advantages:

1. More hygienic with only one user.
2. Much easier for users and their families as the disabled person could defecate / urinate inside the tent, so the family did not have to carry them to the latrines. Only the pot needed taking away for emptying and cleaning.
3. Users can take the chair with them when they leave.

Disadvantages:

1. Privacy inside the tents was limited. In Pakistan, if some disabled adults wanted to use their commodes then all members of the family had to leave the tent, except for one carer.

2. There are hygiene issues when people are living, eating, sleeping and going to the toilet in the same room of a tent.

Recommendations for improvement:

1. Provide a screen or separate screened area outside the tent, so that the disabled person can have some privacy.
2. Commode chairs with wheels would be easier to manoeuvre (but would need locking mechanisms).
3. The chair and pan should have handles for easy use.
4. The pot should be sufficiently deep to prevent it over filling and preventing splash back.
5. The commode chair should be strong and not too slippery, so that the user can sit on it easily.

Ref: From discussions with users facilitated by Jamila Nawaz and Shamma Lal, Public Health Promotion Officers, OXFAM, Pakistan and from observations.

Bedpan / potties

Metal or plastic bedpans and urine containers can be useful for people who are immobile, either due to disability or being in hospital following an operation. If these cannot be found, then children's potties can be used as an alternative. However, these are not ideal for adults due to their height, their size and dignity-related issues. For both options it is important for carers to have somewhere to wash the bedpan or potty and for the carers and people with disabilities to have access to adequate hygiene cloths, water and soap to enable effective good hygiene practice.



Bedpan and male urine container -

Female urine containers were also available in Pakistan

Photos: Saira Raza



Excreta disposal for children with disabilities

Children with disabilities may need smaller sized facilities such as seats and handrails. Potties may be useful for small children. The parents or carers of children with disabilities should also be involved in discussions on the needs of the child for excreta disposal.

Designing and constructing facilities that are accessible for all

Single latrine

Where it is possible to provide household or family latrines, this is usually the preferable option to ensure effective operation and maintenance. The family latrine can be made with accessibility features to meet the specific needs of the person(s) who will use it.

Latrine block

In camp situations however, latrines are often provided in blocks, particularly in the early stages of an emergency where there is a need for rapid implementation and where there may be limited space for minimum distances between shelters and latrines. One latrine in each block should be designed with accessibility features, to allow access for any physically vulnerable users.

Accessible design features of latrines

Accessible latrines should include the following features:

- Distances to facilities from the home or shelter of physically vulnerable persons should be minimised.
- Easy access to the latrine should be ensured via well drained, compacted ground or a slope, which should ideally be <1 in 15 gradient (if steeper then the ramp should also be kept short) and a minimum of 150cm wide for a communal ramp.
- The entrance area to the latrine should be large enough to allow a wheelchair user to manoeuvre.
- Ensure that the door can be opened and closed by the user when the user is inside the latrine.
- Additional space should be provided inside to manoeuvre a wheelchair or for a carer to stand.
- Add a cleanable seat – fixed or moveable.
- Some form of handrail or rope for support when moving to and from the seat.

Approach and entry to the unit

The pathway to the latrine should be smooth and compacted. If there is a slope to reach the latrine then a ramp should be provided in preference to steps. A handrail is needed on at least one side of ramps and steps. Enough flat space should be provided at the top of the slope (and at intermediate points if the slope is long) for resting, manoeuvring and opening and closing doors.

Doors

- An entrance door should be a minimum 80cm wide to provide clear space for wheelchair access.
- An outward opening door leaves more usable space inside.
- A door stop is useful to prevent the door from swinging too far if the door opens outwards.

The user should be able to close the latrine door when inside. See boxes below for ideas for door closing aids.



This concrete ramp provides a smooth access way for this child to the toilet. A kerb edge ensures the wheels of the wheelchair do not fall off the edge. (Jones & Reed, 2005)

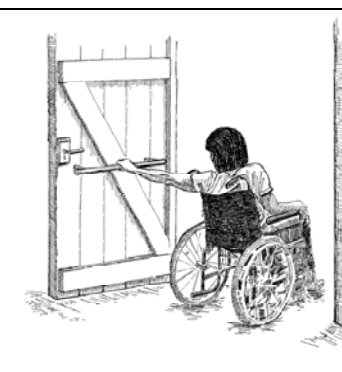

A hand-rail across the width of the door can be easier to reach than a single handle (Jones & Reed, 2005)

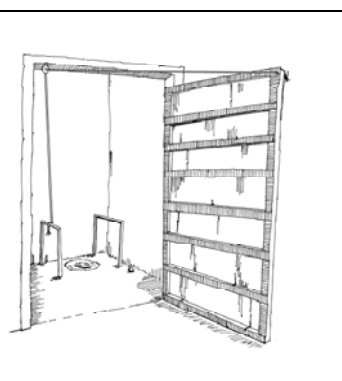

A rope tied onto the handrail and fed through a pulley to the door, can be pulled by the user to close the door (Jones & Reed 2005)

Size of the unit

The more space that can be provided inside the unit the better. There should be enough space:

1. To be able to shut the door when the user is inside.
2. To manoeuvre a wheelchair and for the user to move from the wheelchair to the latrine hole or seat.
3. For the carer to be able to assist where required.

The exact internal dimensions required will depend on a number of factors, including the layout of the unit, the position of the toilet pan in relation to the entrance, and what the latrine will be used for (for example, just as a latrine, or for bathing or clothes washing as well).

If there are men, women or children who are wheelchair users, then ask one of them to assist you to physically determine the space required by asking them to manoeuvre their wheelchair and mark out the area

needed on the ground. Also ask their advice on the layout and design of facilities.

Useful dimensions:

- User and carer by their side - allow 120cm
 - Length of wheelchair and carer – max 130cm
 - Turning circle for a wheelchair – 150cm diameter
- (Jones & Reed, 2005)

Floor surface

The floor surface of the latrine should be firm and non-slip with good drainage, and also be cleanable. Painted concrete is more resistant to moisture. A slightly rough surface is helpful for people who use crutches, but it should not be too rough for those who crawl (Jones & Reed, 2005).

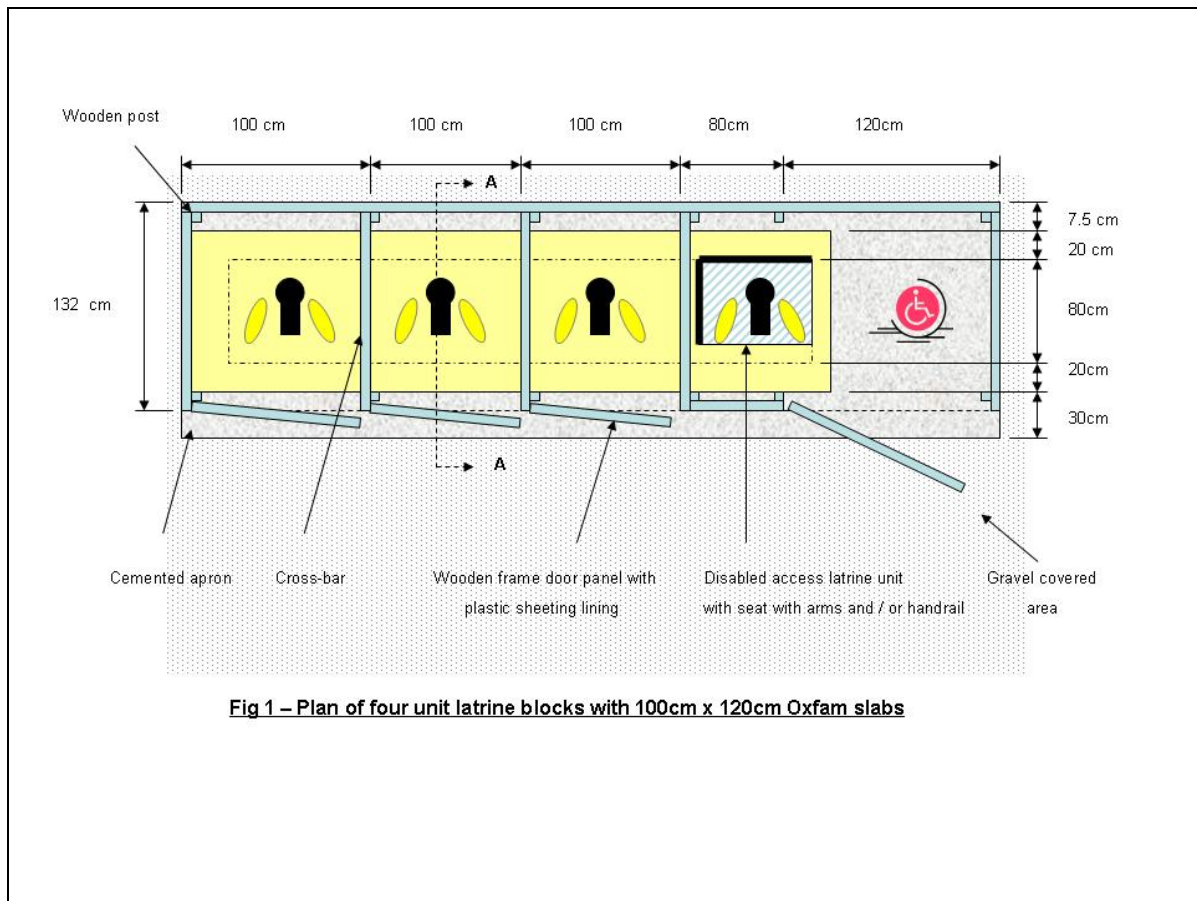
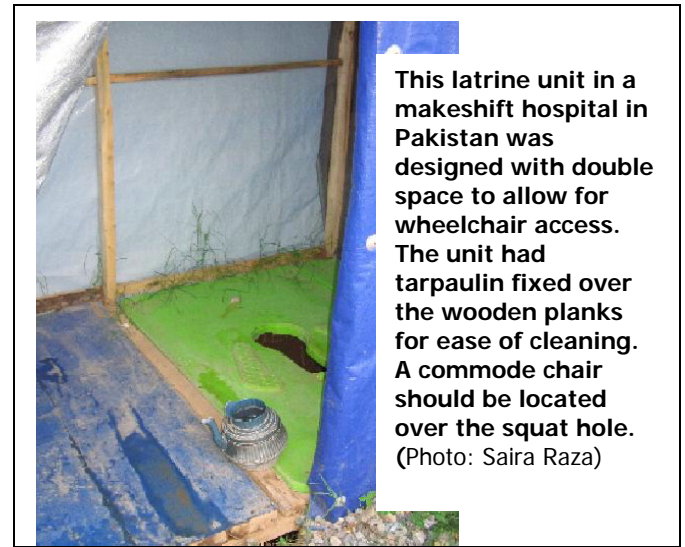

Internal Support

There are two main forms of support to those who need it, by providing either something to hold on to, or something to sit on.

Seat or squat plate

People who are unable to walk or who have weak legs, including elderly people, can find seats helpful. Seats can either be fixed or moveable, and come in a range of sizes, materials (e.g. wood, metal, bamboo), and designs – with or without a back or armrests. Things to consider when designing a seat:

1. It should be strong enough to support the person's weight.
2. It should not be porous and should be easy to clean.
3. It should not slip, so use locating holes for the legs or bracings to support the seat if this is a risk.
4. It should be positioned so that there is enough space for the user to manoeuvre from either standing position, or from sitting in a wheelchair onto the seat.
5. The hole should be large enough to avoid soiling
6. A solid surface to prevent 'splash back' can be added between the squat hole and the users legs.

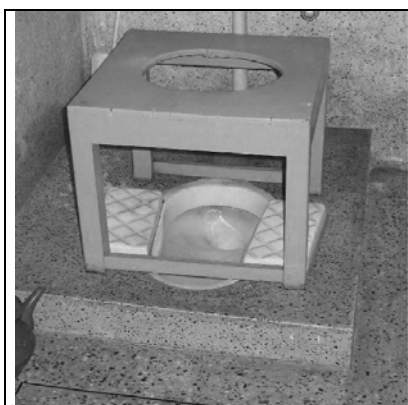

A small painted wooden stool placed over the latrine hole. It does not have a splash guard.

(Jones & Reed, 2005)



This wooden seat was used in a unit for disabled persons (one for male and for one female) in a medical camp in response to the Pakistan earthquake. It was varnished for easy cleaning and had strong arms and back. The users reported finding it easy to use.

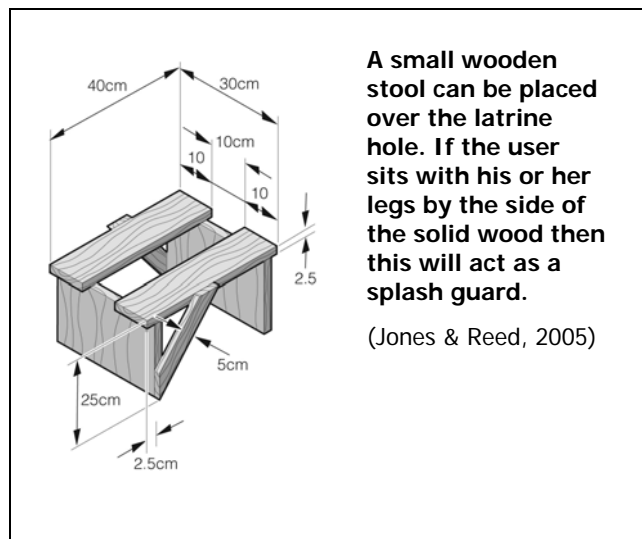

A small wooden stool can be placed over the latrine hole. If the user sits with his or her legs by the side of the solid wood then this will act as a splash guard.

(Jones & Reed, 2005)

Handrails or rope

One of the most useful additions to latrine units is handrails. These can be used to help the user move towards the entrance to the latrine, enter the latrine, move from the standing to squatting position (and vice versa), and for added stability when squatting or sitting. Alternatives to handrails include vertical poles and a rope suspended from a strong beam (see photos).



A simple bamboo handrail to help with bending for squatting

(Jones & Reed, 2005)



Two vertical bamboo poles can be used for stability when squatting and for assistance when moving from standing to squatting position

(Jones & Reed, 2005)



Simple painted metal handrails fixed into the concrete floor and walls. GI / GS pipes and fittings or rolled hollow sections could be used

(Jones & Reed, 2005)



A knotted rope suspended from a secure beam for use in balancing and when moving between standing and squatting position. (This should be considered as a temporary measure only)

(Jones & Reed, 2005)

Public health promotion

Public health promotion should be an integral part of any excreta disposal programme. Particular attention should be given to the following when the PHP is related to facilities or equipment for use by people with disabilities:

1. Particular attention should be made to ensuring the cleanliness of the floor of the units and the seat as some people may find it difficult to manoeuvre around faeces on the floor, or may have to move along the floor. They will also need to sit directly on the seat.
2. If people are paid to clean the units then they should be trained to be aware of the particular cleanliness needs of these units. If they are family latrines then particular PHP efforts should be made with the family members to ensure cleanliness.
3. Where users are bed-bound the carers may have additional needs for water containers, bowls, cloths and soap. Discuss with them their needs.

Hand-washing and bathing facilities

Hand-washing facilities

Hand-washing facilities provided by the latrines should be at a height and location which is easily accessible to both adults and children who have physical disabilities as well as other users.

Bathing facilities

Bathing facilities should be provided as well as latrines, ideally near to the latrines. To make these facilities user friendly for people with disabilities, adding in a washable and easily draining chair or bench (possibly a painted metal frame with woven plastic or rubber strips) can be beneficial as well as ensuring adequate space for the carer to also be present inside the bathing unit.

Bathing facilities should be designed with the same features for accessibility as latrines – easy access, room to manoeuvre and enough room for a carer to stand.

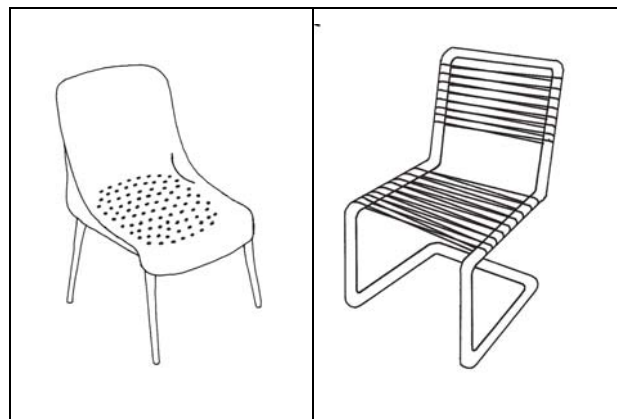

Seats or bathing benches can be added inside bathing cubicles (Source: Van der Hulst, 1993)



A bathing bench with its own water supply fed from a rainwater harvesting tank

Ref: Jones & Reed, 2005

Further information

Jones, H and Reed, R.A. (2005) Water and sanitation for disabled people and other vulnerable groups: designing services for improved accessibility. WEDC, Loughborough University, UK. English: hard copy, CD, French: hard copy from wedc@Lboro.ac.uk

Online: <http://www.Lboro.ac.uk/wedc/auwsfpdp>

Werner, D (1998) Nothing about us without us; developing innovative technologies for, by and with disabled persons, Healthwrights, Palo Alto, CA, USA,.

<http://www.healthwrights.org/books/nothingabout.htm>